

TOPCASETRÄGER EXTREME

Top case carrier | Portatopcase | Porte top-case | Supporto topcase







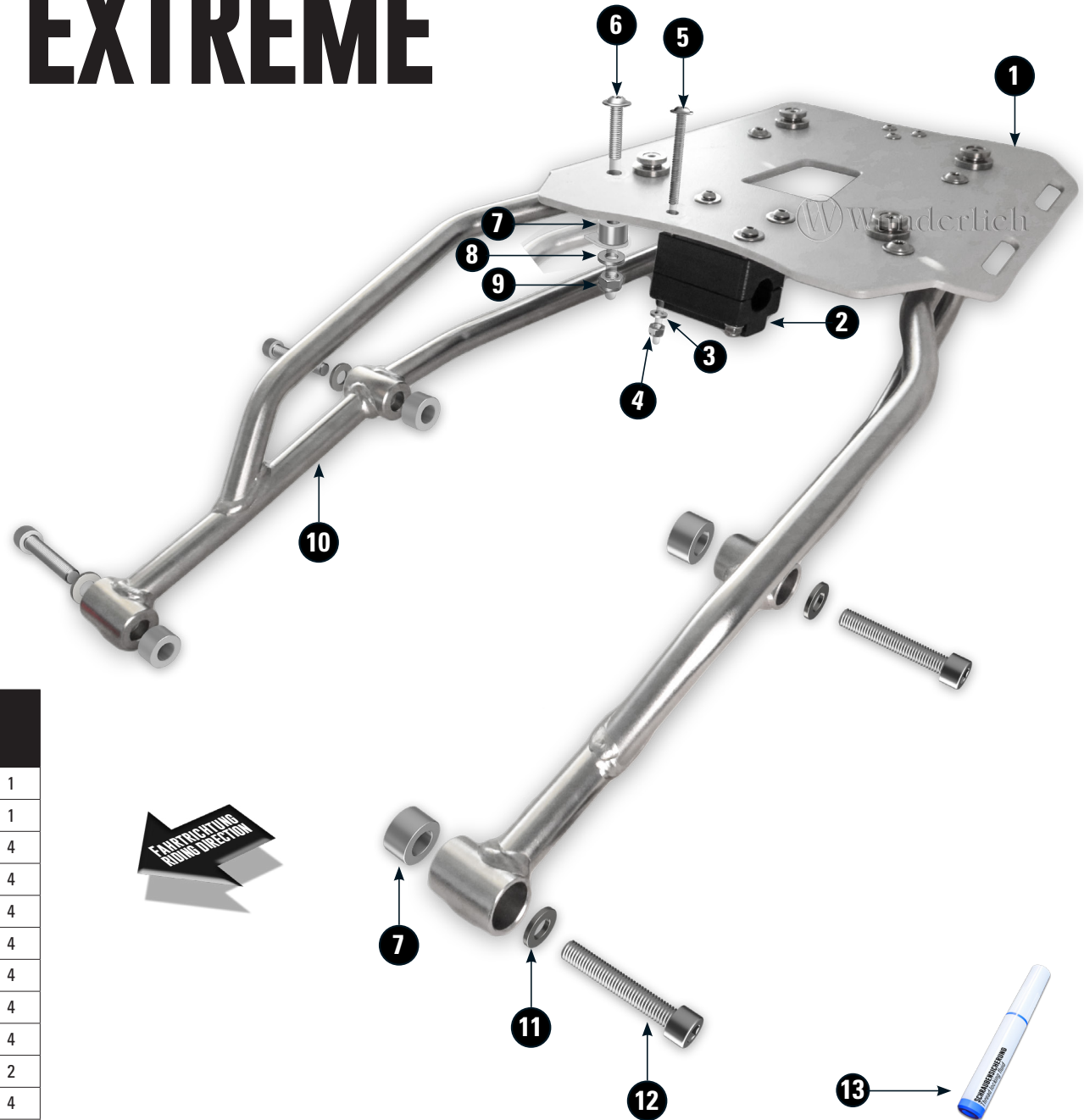

Art.-Nr. 70600-50X

**FAHRTEN MIT BELADENEM TOPCASE VMAX. 130 KM/H.
ZULADUNG MAX. 5 KG.**

Rides with loaded topcase Vmax. 130 Km/h. (80 mph)
max. load 5 Kg.



LEGENDE/KEY/FILE LÉGENDE

-  **Anbau Tipp**
Fitting tip
Astuce de montage
-  **Achtung**
Attention
Attention
-  **Vergrößerung**
Magnification
Grossissement
-  **Montagepaste**
Fitting lubricant
Lubrifiant de montage
-  **Schraube**
Screw
Vis
-  **Schraubensicherung**
Thread locking fluid
Freinfiets
-  **Drehmoment**
Torque
Torque
-  **Reiniger**
Cleaner
Nettoyant

#	Bauteil component composant	DE Die Farben der Abbildungen dienen nur der Veranschaulichung. EN The colors are for illustrating purposes only. FR Les couleurs utilisées sont à titre indicatif seulement.	DIN	ISO	
1	Trägerplatte vormontiert / Preassembled support				1
2	Rohrklemme / Tube clamp				1
3	U-Scheibe / Washer M6		125	7089	4
4	Sechskantmutter / Hex nut M6		985	10511	4
5	Linsenflanschschraube / Lens head screw M6x60		7381	7381	4
6	Linsenflanschschraube / Lens head screw M8x35		7381	7381	4
7	Hülse / Sleeve DØ 20 - dØ8,7 - h 13mm				4
8	U-Scheibe / Washer M8		125	7089	4
9	Sechskantmutter / Hex nut M8		985	10511	4
10	Rechter & linker Träger / Right & left carrier				2
11	U-Scheibe / Washer M8 h 3mm				4
12	Zylinderkopfschraube / Cylinder head screw M8x35		912	4762	4
13	Schraubensicherung / Thread locking fluid				1



Bitte alle Anbauteile lose am Fahrzeug vormontieren und ausrichten. Erst danach die Schrauben nach Vorgabe anziehen.
First, tighten all screws only loosely. After mounting all parts, the screws should be tightened to the torque specified.
Tout d'abord, ne serrez pas toutes les vis sans les serrer. Après avoir monté toutes les pièces, les vis doivent être serrées au couple spécifié.



In Kombination mit dem Kofferträger 70600-000, Hülse ØD 16,0 - Ød 9,0 - h 9,0mm verwenden.
Use in combination with case support 70600-000, sleeve ØD 16.0 - Ød 9.0 - h 9.0mm.
A utiliser en combinaison avec le support de boîtier 70600-000, manchon ØD 16.0 - Ød 9.0 - h 9.0mm.

